

JLRC101

Mixed Fuel Range Cooker

Instruction manual



John Lewis



Important Safety Information

It is important that this instruction manual is kept with the appliance for future reference. Should the appliance be sold or transferred to another owner, or should you move house and leave the appliance, always ensure that the book is supplied with the appliance so that the new owner can get to know the operation of the appliance and the relevant warnings. These warnings have been provided in the interest of safety. You must read them carefully before use or installation by a qualified person. If you are unsure of the meanings of these warnings contact the John Lewis branch from which you purchased the appliance.

Installation

- This cooker must be installed by qualified and competent personnel to the relevant National Standards.
- Refer to the installation information in chapter "Installation" (Pages 7-11).
- This cooker is heavy. Take care when moving it.
- Do not use the oven door handles for lifting or moving the cooker, or for removing the appliance from the packaging.
- This cooker must be installed in an adequately ventilated room.
- The technical data is indicated on the rating plate located on the back of the appliance. This plate must not be removed.
- The adjustment conditions are shown on a label applied to the packaging and the appliance.
- Remove all packaging, both inside and outside the cooker, before using the cooker.
- Before assembling the cooker, remove all the parts that are not firmly attached to it, in particular the pan supports and burners. To lighten the weight of the cooker, the accessories inside the ovens may also be removed, preventing accidental damage during the overturning process.
- If the cooker is set on a pedestal, appropriate measures must be taken to prevent it from sliding off the pedestal.
- Additions or modifications to the appliance are not permitted.
- Repairs to the cooker must only be carried out by trained registered service engineers.

Child Safety

- The cooker should only be used by adults.
- Do not allow children to approach or play with the cooker.
- Do not allow children to sit or climb on the drop down doors.
- Never store items that children may attempt to reach above the appliance.
- Whenever the cooker is in use and in the necessary cooling down period, take care to position the saucepans in a way to prevent burns or overturning. Avoid leaving the oven door open during use and immediately after cooking, the heating elements will still be hot.
- Only allow older children to use the cooker with adult supervision.

Use

- This cooker is intended for domestic cooking only. It is not designed for commercial or industrial purposes.
- Remove all stickers and film from the glass doors and the stainless steel cabinet.
- Cookers become very hot with use, and retain their heat for long periods after use. Care should be taken to avoid touching the hob area and the inside of the oven until fully cooled.
- There is the risk of burns from the appliance if used carelessly or incorrectly.
- Cables from other electrical appliances must not touch the hot surface of the appliance or hot cookware.
- Overheated fat and oil can ignite quickly. When cooking with fat or oil (e.g. frying chips) do not leave the appliance unattended.
- Do not leave cookware containing foodstuffs, e.g. fat or oil in or on the oven or on the hob in case they are inadvertently switched ON.
- Ensure that you switch the gas hobs and ovens OFF after use.
- Do not ignite a gas hob without a saucepan over the burner.
- When in use the gas hob will produce heat and moisture in the room in which it has been installed. Ensure there is a continuous air supply, keeping air vents in good condition or installing a cooker hood with a vented outlet.
- When using the hob for a long period of time, opening a window or increasing the extractor speed should improve the ventilation.
- All the cooker's vents must be free of obstructed to ensure ventilation of the oven cavity.
- Do not use the cooker if it is in contact with water.
- Do not operate the cooker with wet hands.
- Always stand back from the cooker when opening the oven doors during cooking or at the end of it, to allow any build up of steam or heat to release.
- Unstable or misshapen pans should not be used on the hob as they can cause an accident by tipping or spillage.
- Always support the grill pan when it is in the withdrawn or partially withdrawn position.
- The cooker must not be used as a work surface or as a storage surface.
- Never line any part of the oven with aluminium foil.
- Do not allow heatproof cooking materials, e.g. roasting bags, to come into contact with the oven elements.

- Do not place or store sealed cans, aerosols, flammable liquids, highly inflammable materials or fusible objects (e.g. plastics film, plastic, aluminium) inside, on, above or near the cooker.
- Do not hang towels, dishcloths or clothes from the oven or its handles.
- Always use oven gloves to remove and replace food in the oven.

Maintenance and Cleaning

- For hygiene and safety reasons this cooker should be kept clean at all times. A build-up of fats or other foodstuffs could result in a fire especially in the grill pan.
- Always allow the cooker to cool down and ensure it is switched off at the wall switch prior to carrying out any cleaning / maintenance work.
- Only clean the cooker in accordance with the instructions contained within this manual.
- For cleaning or for maintenance work, the electrical supply to the appliance must be switched off and the appliance must be cooled down.
- For safety reasons, the cleaning of the cooker with steam jet or high-pressure cleaning equipment is not permitted.

Service

- Before leaving the factory, this cooker has been tested and set up by qualified, specialist personnel, to guarantee the best operating results. Each repair or adjustment that may subsequently be necessary must be carried out with the utmost care and attention. Therefore this cooker should only be repaired or serviced by an authorised service engineer and only genuine approved spare parts should be used.



Environmental Information

- After installation, please dispose of the packaging with due regard to safety and the environment.
- When disposing of an old appliance, make it unusable, by cutting off the cable and make safe any components, which might be dangerous for children (remove doors etc.).
- The Symbol  on the product or on its packaging indicates that this product cannot be treated as household waste. Instead it should be taken to an appropriate collection point for recycling of electrical and electronic equipment. By ensuring this product is disposed of correctly, you will help prevent potential negative consequences for the environment and human health, which could otherwise be caused by inappropriate waste handling of this product. For more detailed information about recycling of this product, please contact your local city office, your household waste disposal service or the shop where you purchased the product.

Contents

Important Safety Information	3
Description of the Appliance	6
Installation	7
Technical Specifications	7
Electrical Connection	8
• Permanent Connection	8
• Electric power cable section	8
Gas Connection	9
Stability chain	10
Conversion from Natural Gas to LPG	11
• Minimum flow of valved cooking hob taps	11
• Minimum flow of non-valved cooking hob taps	11
• Connecting to LPG	11
• General injectors table	11
Description of the cooktop	12
Assembly	12
• Fitting the adjustable feet	12
• Levelling the cooker to the floor	12
The Control Panel	13
• The front panel	13
• Description of hob burner knob	13
• Description of electric oven knobs	13
• Description of auxiliary electric oven knob	14
• Description and use of the end of cooking display on the electric oven	14
Using the Hob	16
• Switching on the burners	16
• One touch ignition and safety valve	16
• Manual ignition	16
• Switching off the burners	16
• Suggestions for using the hob burners correctly	16
Using the Ovens	17
• General warnings	17
• Heating failure of the oven	17
• Storage Drawer	17
• Using the electric multifunction oven	17
• Using the auxiliary oven with natural convection	18
Cooking suggestions	20
Recommended cooking tables	21
Maintenance and Cleaning	23
• Cleaning stainless steel	23
• Cleaning enamelled surfaces	23
• Cleaning the knobs and the control panel	23
• Cleaning the pan supports and burners	23
• Cleaning the igniter plugs and thermocouples	23
• Cleaning the oven	24
• Cleaning the oven walls	24
• Cleaning the door	24
• Replacing the light bulb	24
Special Maintenance	25
• Removing the oven door	25
• Removing the shelf runner grid	25
• Removal and cleaning the oven fan	25
Something Not Working	26
Repairs - After Sales Service	27
• Spare parts	27

Guide to using the Instruction Manual

The following symbols will be found in the text to guide you throughout the instructions:

 **Safety Instructions**

 **Hints and Tips**

 **Environmental Information**

 This appliance complies with the following **E.E.C. Directives:**

- **73/23/EEC** (Low Voltage Directive) and subsequent modifications.
- **89/336/EEC** (Electromagnetic Disturbance Directive) and subsequent modifications.
- **90/396/EEC** (Gas Appliances Directive) and subsequent modifications.
- **89/109/EEC** (Material in contact with food Directive) and subsequent modifications.

Description of the Appliance

- 1 Cooktop
- 2 Control Panel
- 3 Multifunction Main Oven
- 4 Conventional Second Oven
- 5 Storage Drawer
- 6 Adjustable Feet

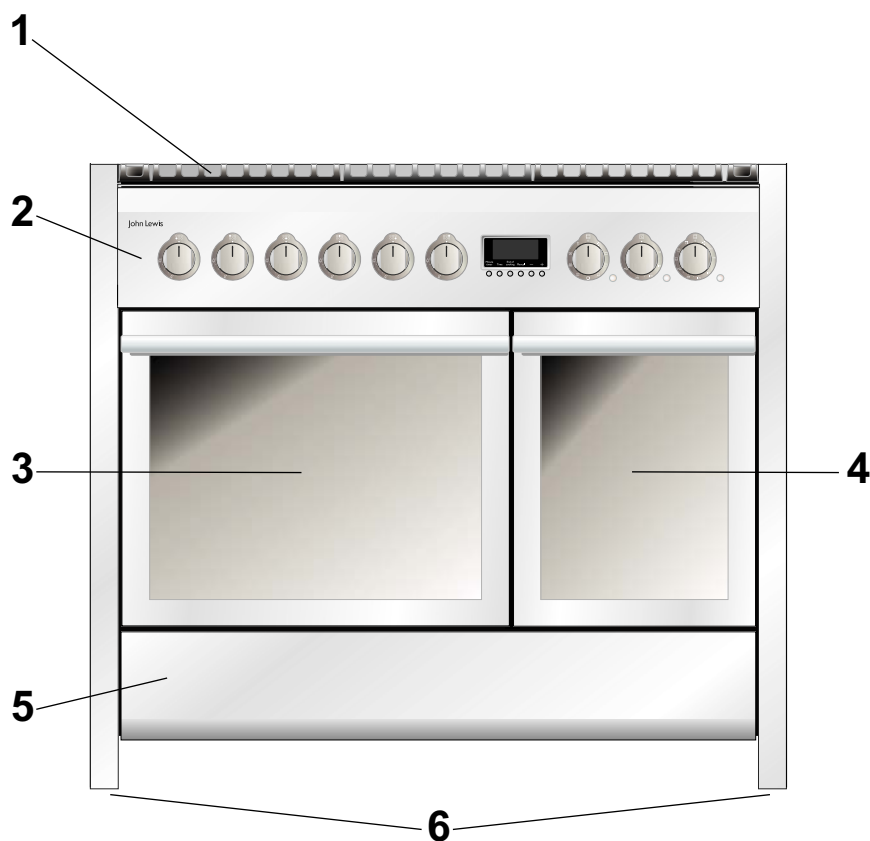

Installation

! It is dangerous to alter the specifications or attempt to modify this product in any way.

! Care must be taken to ensure that the appliance does not stand on the electrical supply cable (not supplied).

! Any electrical work required to install this appliance should be carried out by a qualified electrician or competent person.

Technical Specifications

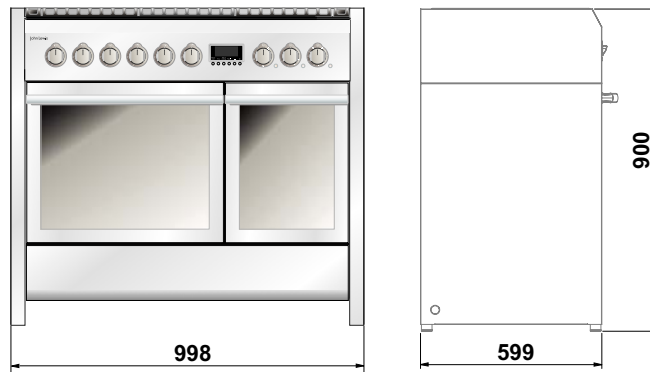

Appliance dimensions	Width Depth Height	998mm 599mm 900mm
Connection voltage	230 V ~ 50Hz	
Maximum connection load	3.9 kW	

Gas Hobs		
Position	Type	Power Watt Max/Min
Rear Left	Semi-rapid	1750/440
Rear Centre	Triple ring	3300/1500
Rear Right	Rapid	3000/750
Front Left	Triple ring	3300/1500
Front Centre	Semi-rapid	1750/440
Front Right	Simmer	1000/300

Electric Ovens		
Position	Type	Power
Left	Multifunction	2.2 kW
Right	Conventional	1.7 kW

Electrical Connection

Any electrical work required to install this appliance should be carried out by a qualified electrician or competent person.



WARNING: THIS APPLIANCE MUST BE EARTHED. Should the appliance power supply cable need to be replaced, this must be carried out by a Service Force agent (see page 27). The manufacturer declines any liability should this safety measure not be observed.

To replace the electric cable, it is necessary to access the terminal board. It is located on the back of the appliance, at the top left, (see diagram below).

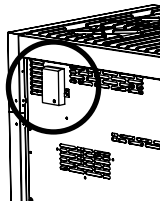

Proceed as follows:

- Open the terminal board box;
- Unscrew the screw **A** that locks the cable;
- Loosen the screw contacts and replace the cable with one of the same length that corresponds to the specifications in the table in section "Electric power cable section";
- The "**yellow-green**" earth wire must be connected to the terminal \oplus and must be approximately **20 mm** longer than the line cables;
- The neutral "**blue**" wire must be connected to the terminal marked with the letter **N**;
- The line wire "**brown**" must be connected to the terminal marked with the letter **L**.

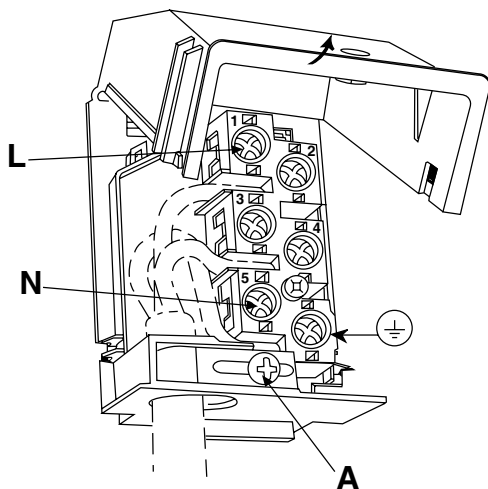

Permanent connection

For permanent connection it is necessary to install a double pole switch between the appliance and the electricity supply (mains), with a minimum gap of 3mm between the switch contacts and of a type suitable for the required load in compliance with the current electrical regulations.

The switch must not break the **yellow** and **green** earth cable at any point.

Electric power cable section

According to the type of power supply, use a cable that conforms to the following table.

Running at 230V1N~: use a tripolar cable type H05RR-F (cable measuring $3 \times 2.5 \text{ mm}^2$).

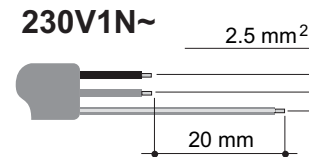

The end to be connected to the appliance must have the earth wire (**yellow-green**) at least **20 mm** longer.

Gas Connection

The room containing the appliance should have an air supply in accordance with B.S. 5440 part 2.

1. All rooms require an opening window or equivalent, and some rooms will require a permanent vent as well.
2. For room volumes up to 5m³ an air vent of 100cm² is required.
3. If the room has a door that opens directly to the outside, and the room exceeds 10m³ no air vent is required.
4. For room volumes between 5m³ and 10m³ an air vent of 50cm² is required.
5. If there are other fuel burning appliances in the same room B.S. 5440 part 2 should be consulted to determine the air vent requirements.
6. The appliance must not be installed in a bed sitting room of less than 20m or in a bathroom or shower room.

i We recommend checking that the appliance is properly set up for the type of gas distributed. The threaded 1/2" gas connection pipe is located at the rear on the right hand side of the appliance.

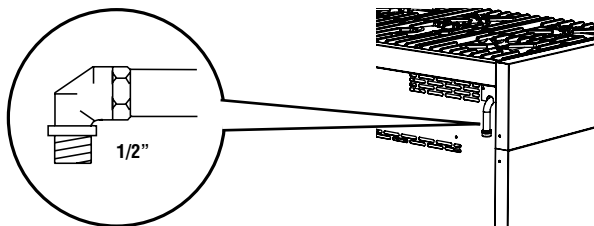

The cooker is designed to match the depth of standard 600mm worktops. An adaptor back plate should, therefore, be fitted within the shaded area shown to allow the cooker to be pushed in fully and chased to the wall.

Connection to the cooker should be made with an approved appliance flexible connection to BS 669. A length of 0.9 to 1.25m is recommended. The length of hose chosen should be such that when the cooker is in situ, the hose does not touch the floor.

The temperature rise of areas at the rear of the cooker that are likely to come in contact with the flexible hose do not exceed **70°C**.

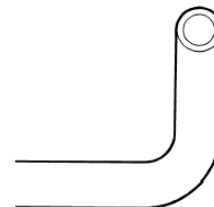
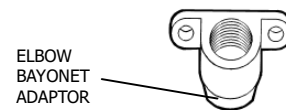
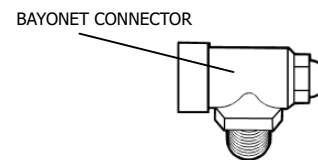
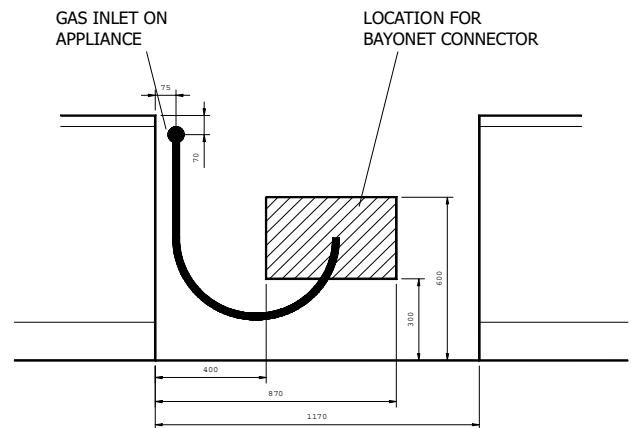

Stability chain

The cooker is fitted with a stability device such as a proprietary stability chain as shown and firmly secured to the fabric of the building.

Whatever the position, remember to leave enough room for the cooker to be pulled out for cleaning and service.

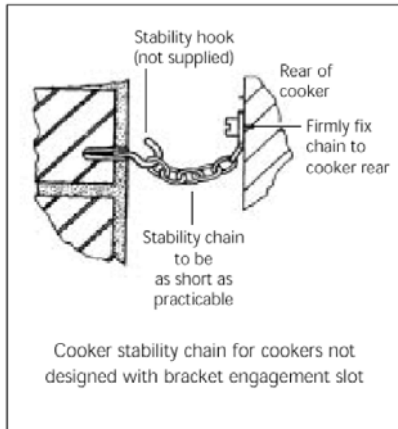

The wall behind the cooker between the hotplate and 450mm above, and across the width of the cooker, must be an incombustible material such as ceramic wall tiles.

This appliance is designed not to project in front of standard 600mm worktops (excluding handles). To achieve the best fit the cooker must be pushed against the wall.

i As this appliance is very heavy it should be situated on a suitably hard surface as to ensure servicing and installation is made possible with minimal impact on the floor surface.

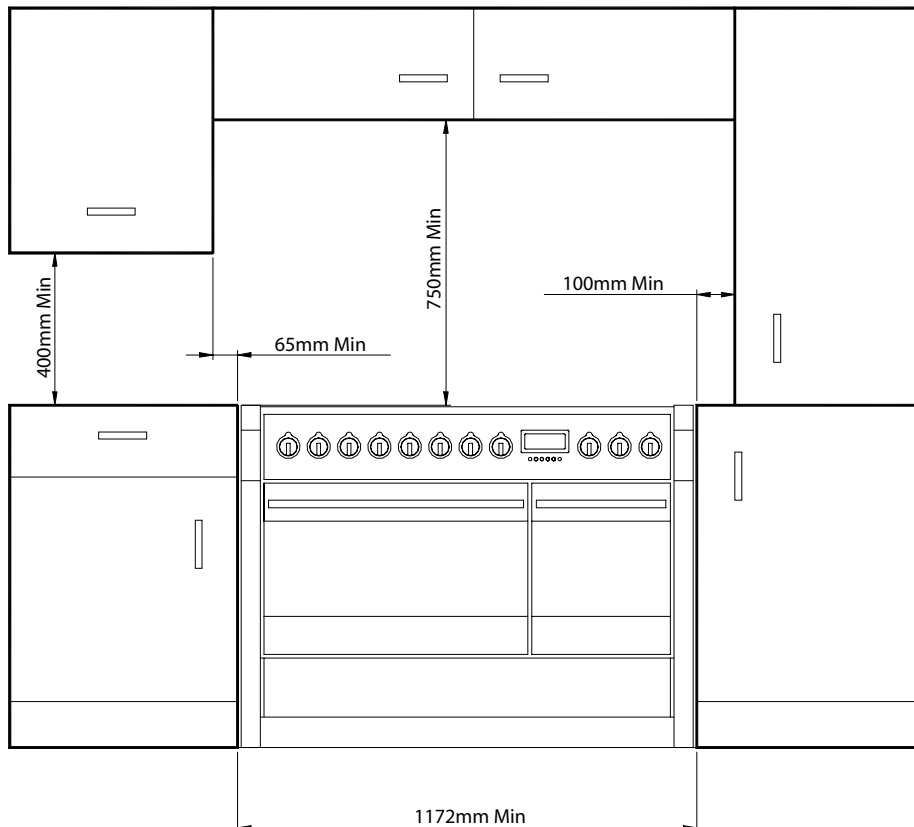

Conversion from Natural Gas to LPG

If the cooking appliance is set up for a **different** type of gas than that available, its injectors must be replaced, the minimum flow regulated. In order to replace the injectors in the cooking hob, it is necessary to carry out the following operations:

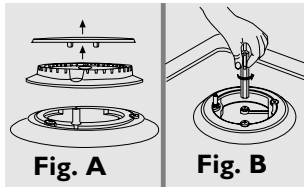

- remove the pan supports;
- remove the burners and burner caps (Fig. A);
- take out the injector (Fig. B) and replace it with one suitable for the new type of gas (see "General injectors table");
- replace the gas label (on the rear of the appliance) with the new one provided with the injectors kit;
- refit all parts by following the disassembly instructions in reverse order and taking care to position the burner cap correctly on the burner.

Minimum flow of valved cooking hob taps

- Switch on the burner and turn the control knob towards the minimum flow position Δ ;
- remove the knob;
- using a screwdriver, adjust the internal screw **Z** until the correct low flame is obtained;
- refit the knob.

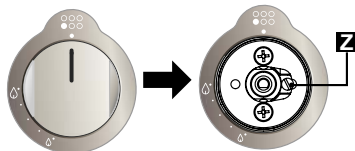

Minimum flow of non-valved cooking hob taps

- Switch on the burner and turn the control knob towards the minimum flow position Δ ;
- remove the knob;
- insert a small screwdriver into the rod of the tap and adjust the internal screw **Z** until the correct low flame is obtained;
- refit the knob.

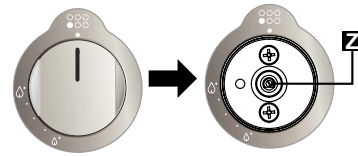

i Unscrew the adjustment screw **Z** to increase the flow, or tighten it to reduce the flow. The adjustment is correct when the low flame measures approximately 3 or 4 mm. When changing quickly from maximum to minimum flow and vice versa make sure that the flame does not go out.

Connecting to LPG

Use a pressure regulator and connect to the cylinder in compliance with the guidelines set out in standards regulations in force.

i L.P.G. cookers **MUST NOT** be installed below ground level i.e. in a basement or aboard any boat, yacht or other vessel.

General injectors table

TYPE OF GAS	mBar	INJECTOR NO.		BURNERS POSITION TYPE	POWER Watts		MAX. CONSUMPTION
		INJECTOR	BY-PASS		MAX.	MIN.	
NATURAL GAS G20 (E)	20	115	44 GAP	RAPID	3000	750	286 l/h
		97	34 GAP	SEMI-RAPID	1750	440	167 l/h
		72	27 GAP	SIMMER	1000	300	95 l/h
		128	60 GAP	TRIPLE RING (A)*	3300	1500	314 l/h
		128	60 GAP	TRIPLE RING (D)*	3300	1500	314 l/h
LPG BUTANE PROPANE G30/G31	28-30/37	85	44 GAP	RAPID	3000	750	219 g/h
		65	34 GAP	SEMI-RAPID	1750	440	128 g/h
		50	27 GAP	SIMMER	1000	300	73 g/h
		93	60 GAP	TRIPLE RING (A)*	3300	1500	240 g/h
		93	60 GAP	TRIPLE RING (D)*	3300	1500	240 g/h

* Position **A**: front left, position **D**: centre rear (see also "Description of the cooktop").

Description of the cooktop

A	Triple ring burner	3.30 kW
B	Semi-rapid burner	1.75 kW
C	Semi-rapid burner	1.75 kW
D	Triple ring burner	3.30 kW
E	Simmer burner	1.00 kW
F	Rapid burner	3.00 kW

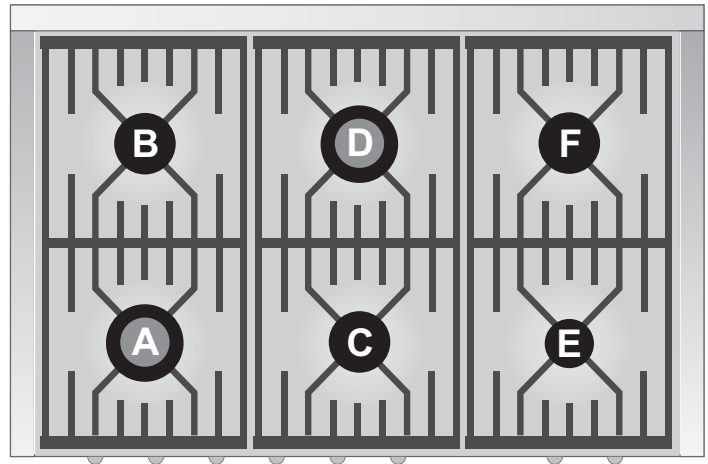

Assembly

Fitting the adjustable feet

! Before assembling the cooker remove all the parts that are not firmly attached to it, in particular the pan supports and burners. To lighten the weight of the cooker, the accessories inside the ovens may also be removed, preventing accidental damage during the overturning process.

The cooker is delivered with the feet removed. Before moving and connecting up the cooker, take the feet from the packaging and screw them onto the cooker. This can be done in one of two ways:

- A** Lifting the cooker off the floor.
- B** Laying the cooker on its back.

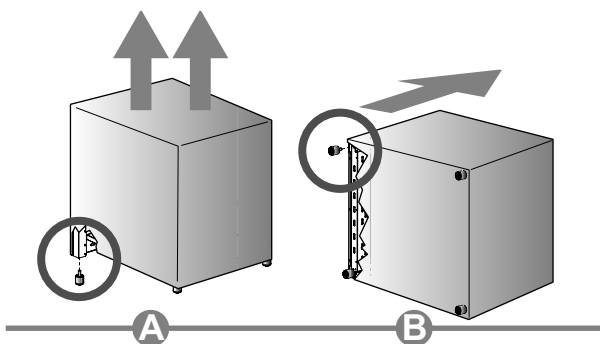

The final adjustment of the feet to level the Cooker to the floor will be done after the gas and electrical connections have been made.

! Should it be necessary to move the cooker, screw the feet in completely and carry out the final levelling adjustment only when the gas and electrical connections have been made.

Levelling the cooker to the floor

After having made the electrical and gas hook-ups, level the cooker to the floor using the adjustable feet that were previously screwed onto the bottom of the cooker.

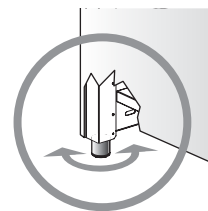

! Should it be necessary to drag the cooker, screw the feet in completely and carry out the final regulation only when the other operations are completed.





The Control Panel



The front control panel







All the commands and controls for the using the hob and ovens are on the front control panel.

Description of hob burner knob

The flame is lit by simultaneously pressing in and turning the control knob anticlockwise to the low flame symbol  . To regulate the flow of the flame, turn the control knob between the maximum  and minimum  settings. Turn off the burner by returning the control knob to position  .



Layout of burners - Description of symbols

-  REAR LEFT
-  REAR RIGHT
-  REAR CENTRE
-  FRONT CENTRE
-  FRONT LEFT
-  FRONT RIGHT









Description of electric oven knobs

The main electric oven is controlled by two knobs: **function control knob** and **thermostat control knob**. They allow you to choose the most suitable cooking function for different food types, by switching on the appropriate heating elements and setting the required temperature (from **50°C** to **Max**).



Below the oven knobs there are two warning lights: the **red light** signals the oven is working; the **orange light** indicates that the required temperature has been reached. The **orange light** switches on and off to indicate when heating automatically kicks in to maintain the temperature inside the oven at the level set on the thermostat knob. The oven has an **internal light**. The light is always on while the oven is working. It can be switched on when the oven is off, for cleaning purposes, by turning the function control knob to the symbol  .

Description of symbols on the function control knob

-  OVEN LIGHT
-  CONVENTIONAL COOKING
-  TOP HEAT
-  BOTTOM HEAT
-  GRILL
-  FAN GRILLING
-  PIZZA SETTING
-  FAN COOKING
-  DEFROST

Description of second electric oven control knob

The second electric oven is equipped with Conventional cooking and is controlled by a single control knob. This allows the user to choose the most suitable temperature for different recipes, by switching on the heating elements appropriately and setting the required temperature (**60 to Max**). Using the same control knob it is also possible to set the functions described below.



Below the second oven knob there is an **orange light**, which indicates when the oven has reached the required temperature. The **orange light** switches on and off to indicate when the heating automatically kicks in to maintain the temperature inside the second oven.

The second oven has an **internal light**. The light is always on while the oven is working. It can be switched on when the oven is off, for cleaning purposes, by turning the function control knob to the symbol .

Description of symbols on second electric oven control knob

 OVEN LIGHT

60÷Max CONVENTIONAL COOKING

 BOTTOM HEAT

 TOP HEAT

 GRILL

Description and use of the LED digital display

The LED digital display can electronically control the operation of the oven. Setting the time enables the user to set the oven to switch on and off at the required times.

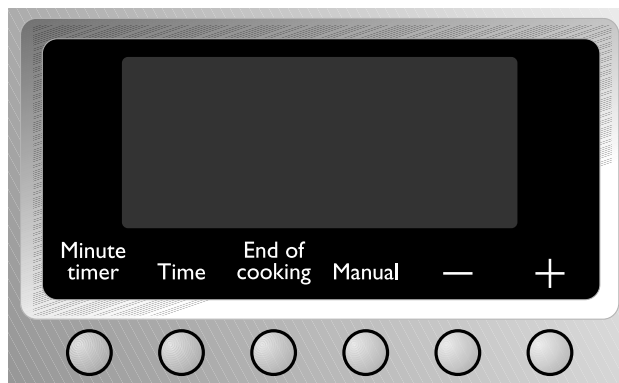

Minute timer

Time

End of cooking

Manual

-

+

TIMER BUTTON

COOKING TIME BUTTON

END OF COOKING BUTTON

MANUAL OPERATION BUTTON

DECREASE VALUE BUTTON

INCREASE VALUE BUTTON

Setting the time

When using the oven for the first time, or after a power cut, the display flashes regularly showing . Press the **Manual** button to stop the display flashing. Press the Value button - or + **within 5 seconds** until the current time appears in the display.



Before setting the End of Cooking timer, you must select the required cooking function and temperature.

Semi-Automatic Cooking

This setting automatically switches off the oven when required and should be used when the oven is already on. Press the **Time** button and the display will show the figures 0:00; hold down and at the same time press one of the value buttons - or + to set the cooking duration. Release the **Time** button to begin the countdown of the selected cooking time. The display will show the current time together with symbols **AUTO** and 🕒.

Automatic Cooking

This setting switches the oven on and off automatically. Press the **Time** button and the display will show the figures 0:00; hold down and at the same time press one of the Value buttons - or + to set the cooking duration. Press the **End of cooking** button. The display shows the sum of the current time plus the cooking duration. Hold down and at the same time press the value buttons - or + to set the time you would like the food to be ready for. Release the **End of cooking** button to begin the programmed countdown. The display shows the current time together with symbols **AUTO** and 🕒.

i After you have set the Automatic timer, press button **Time** to see the remaining cooking time. Press button **End of cooking** to see the end of cooking time.

End of cooking

At the end of the programmed cooking time, the oven switches off automatically and an intermittent bell rings. After switching off the bell, the display once again shows the current time together with symbol 🕒, which indicates the oven has returned to the manual setting.

Adjusting the volume of the bell

The volume of the bell can be varied (3 levels) by pressing, whilst it is ringing, the Value button -

Switching off the bell

You can switch it the bell off manually by pressing the **Manual** button or any of the timer buttons. The bell automatically stops ringing after seven minutes.

i After pressing the **Manual** button the oven begins to operate once again: to switch it off, turn the function control knob and the thermostat control knob to “0”.

The oven switches off regardless of the cooking function or temperature selected and the **AUTO** symbol flashes. To stop the **AUTO** symbol flashing, press the **Manual** button. Once the bell is switched off, the oven begins to operate again. To switch the oven off, turn the function control knob and thermostat control knob to “0”.

Timer

The LED digital display can also be used as a simple timer.

i Using the display as a simple timer does not interrupt the operation of the oven at the end of the set time.

Press the **Minute timer** button and the display shows the figures 0:00. Hold down Minute timer and at the same time press the value buttons - or +. Release the button **Minute timer** to begin the programmed countdown and the display shows symbols 🕒 and 🕒.

After programming the timer, the display once more shows the current time. To display the time remaining again, press the **Minute timer** button.

i You cannot set inconsistent values when using the automatic timer. (For example, a cooking time that would be longer than the required end of cooking time).

Cancelling set data

Whilst the timer is set, hold down the button for the function you wish to cancel and reduce the time to the value 0:00 using the Value buttons - or +. Cancelling the selected timer function means the cooker reverts to the manual setting.

Changing set data

The times set for cooking and ending can be changed by holding down the required function button and pressing the Value buttons - or + until the display shows the new times.

Using the Hob



Before use make sure the **Burner caps and Pan supports** are correctly fitted.



During normal use the cooker will get hot. **Caution should therefore be used. Do not allow children to approach or play with the cooker; whenever the hob is in use and in the necessary cooling down period, take care to position the saucepans in a way that prevents burns or overturning.**

Switching on the burners

The hob burner control knobs have the following symbols:



- tap closed
- 🔥 high flame
- 🔥 low flame

The low flame setting is found by turning the control knob anti-clockwise all the way. All intermediate settings are selected between the high and low flame. The control knob cannot be set between high flame and tap closed.

One touch ignition and safety valve

The hob burners are equipped with a "one touch" ignition system. To switch on one of the burners, press in the appropriate control knob and turn it anti-clockwise to the low setting . Hold in the control knob to activate the "one touch" ignition. Continue holding the control knob in for 10 seconds, to allow the safety valve to open. Should the burner switch off accidentally, the safety (thermocouple) valve will close and stop the flow of gas, even when the tap is open.

Manual ignition

To manually light one of the burners, press the appropriate control knob in and turn it anti-clockwise to the low setting  and use a piezo gas lighter to ignite the gas. Adjust the flame and release the knob.

Switching off the burners

At the end of the cooking, return the knob to position .

Suggestions for using the hob burners correctly

The diameter of the base of saucepan or frying pan should fit the diameter of the burner used (see table below). The burner flame must never be wider than the diameter of the pan. Always use pans with a flat base. Where possible use pans with a lid, as this reduces the level of gas required. Using only the required amount of water for vegetables, potatoes, etc, will reduce the cooking times.

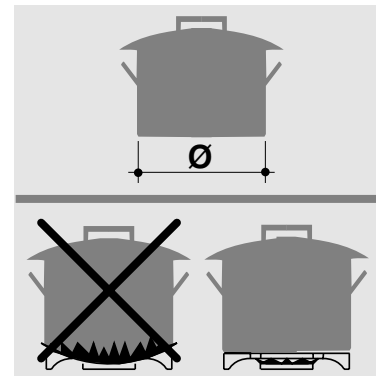

Burner	Pan Diameter (in cm)
Rapid	from 24 to 26
Semi-rapid	from 16 to 22
Simmer	from 8 to 14
Triple ring	from 16 to 35

Using the Ovens



General warnings

 **During normal use the cooker will get hot. Caution should therefore be used. Avoid leaving the oven door open during use and immediately after cooking, the heating elements will still be hot.**

 **Do not allow children to approach or play with the cooker.**

 **Do not allow children to sit or climb on the drop down doors.**

 **Do not cook food on the base of the oven.**

 **When using the oven for the first time, or after a power cut, the display flashes regularly indicating  , to set the display, refer to the section "Setting the Time" on page 14.**

 **Do not attempt to disassemble the oven door without consulting the relative instructions carefully (refer to the section "Removing the oven door") on page 25. The hinges on the oven door may injure the hands.**

Heating failure of the oven

If during normal use there is a failure in the heating of the oven and the programmer display begins to flash and returns to  :

- Check to see if there has been an electrical power failure.

If the failure occurs again after the cooking program has been restarted, this means that the safety device has been tripped. The safety device will intervene in the event of a thermostat fault and prevent the oven overheating. In such cases we recommend that you do not use the oven again and you contact the John Lewis extended warranty administrators, see "Repairs - After Sales Service" on page 27.

Storage drawer

The Storage Drawer is situated beneath the ovens. Only store metal trays or cooking accessories in this compartment.

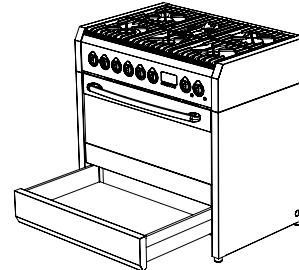

 **Do not store inflammable material such as cloths, paper or similar; the heat from the oven could create a fire risk.**

Using the electric multifunction main oven

 **The LED digital display, the left and centre oven control knobs only apply to the main multifunction oven, they do not operate the Conventional second oven.**

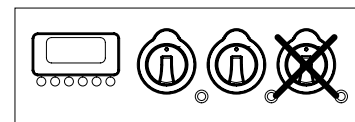





Switching on the ovens for the first time

The first time the oven is used, the oven may smoke or give off an acrid smell. This is caused by oily residues from manufacturing and could transfer unpleasant odours or flavours to the food. **Before using the ovens for the first time, heat the ovens to their maximum temperatures for 30 to 40 minutes with the doors closed and wait until the smoke or odours have stopped.**



i To prevent any steam in the oven from scalding you as you open the oven door, turn the function control switch to “0”, or function ; open the door in two stages. Hold the door partly open (approximately 5cm) for 4 - 5 seconds, then open the door completely. Should you need to adjust the food, leave the door open for as short a time as possible to prevent the oven temperature from lowering to such an extent as to jeopardise the cooking. You may need to add a little extra cooking time.

Conventional cooking

Turn the function control knob to position  and the thermostat control knob to the required temperature. For heating only above or below the food, set the function control knob to position  (Top Heat) or  (Bottom Heat). For a more even heat throughout the oven cavity, turn the function control knob to position .

i After preheating and putting the food in the oven an air flow between the upper side of the door and the lower side of the hob may be noticed. In case that does not happen, switch off the appliance and contact the **Technical Service** immediately.

Fan cooking

Turn the function control knob to position  and the thermostat control knob to the required temperature. Cooking times and temperatures can be reduced.



Fan grilling

Turn the function control knob to position  and the thermostat control knob to the maximum temperature setting (**Max**).

Grilling

Turn the function control knob to position  and the thermostat control knob to the maximum temperature setting (**Max**).

Defrosting

Turn the function control knob to position  and leave the thermostat control knob in position . The fan is switched on but no heat is used. Room temperature air is circulated around the oven, encouraging the frozen food to defrost.

Switching off the oven

The oven is switched off by turning the thermostat control knob to position .

Using the second oven with conventional cooking

i The right hand oven control knob only applies to the conventional second oven, it will not operate the main multifunction oven.

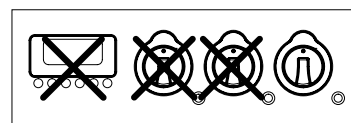

The second is equipped with:

- A heating element positioned on the base of the oven (Bottom Heat);
- A heating element positioned on the ceiling of the oven (Top Heat) + a grill element.

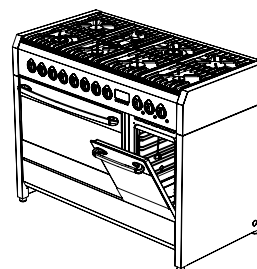

Switching on the second oven for the first time

The first time the oven is used, the oven may smoke or give off an acrid smell. This is caused by oily residue from manufacturing and may transfer unpleasant odours or flavours to food. **Before putting food in the oven, heat the second oven to the maximum temperature for 30-40 minutes with the door closed and wait until the smoke or odour has stopped.**



To start heating the second oven, select the temperature (from **60** to **Max**) or the required function by turning the thermostat control knob.

Cooking with the grill (second oven)

Turn the thermostat control knob to position  and let the second oven preheat for approximately 5 minutes. For correct operations, position the grill on the third shelf support from the bottom. To vary the intensity of the heat move the grill pan away from the grill by lowering the grill pan to a different shelf position. This accommodates personal taste and different cooking requirements. A cooling system prevents the control knobs from getting too hot.

Switching off the second oven

The oven is switched off by returning the thermostat control knob to "0".

Cooking suggestions

Suggestions for using the oven correctly



The multifunction oven allows you to cook different foods in the best way; using the fan, conventional cooking or with the grill, for example. The oven door should be closed for all types of cooking.

Conventional cooking

When using this setting, the heat comes from the top and the bottom elements. This allows you to cook on a single middle level. If the dish requires extra base browning or top browning, use the lower or upper shelf supports. Conventional cooking is recommended for all foods that require high cooking temperatures, or long brazing times. This system is also recommended when cooking with recipients made of terracotta, porcelain and similar materials.

Fan cooking

With this type of cooking, the air inside the oven is heated by the element around the fan situated behind the back panel. The fan circulates hot air to maintain an even temperature inside the oven. The benefits of cooking with this function are:

As the fan oven quickly reaches temperature, it is not usually necessary to preheat the oven, however for certain foods e.g. bread, scones, souffles, etc. the best results are achieved if you preheat the oven first.

Fan oven cooking generally requires lower temperatures than Conventional cooking. Follow the recommended chart on page 21.

The fan oven has uniform heating on all shelf positions.

This means that batches of the same foods can be cooked in the oven at the same time.

There is no mixing of flavors between dishes so sweet and savoury foods can be cooked at the same time.

Grilling

With this type of cooking the heat comes from the top grill element. Preheat the grill for a few minutes before cooking and sealing meats. Lightly brush meat and fish with a little oil and place on the grid in the grill. Adjust the heat during grilling by moving closer to or further away from the grill element. This avoids burning the surface and cooking too little inside. The food should be turned over during cooking as required. Suitable for: fairly thin meat



Pour 1 or 2 glasses of water into the drip tray to avoid smoke forming due to drops of juice or fat. While cooking with the grill, the drip tray should always be positioned in the 1st guide from the bottom.

Fan grilling

A combination of the grill and fan oven .

This type of cooking allows the heat to penetrate gradually into the food, even though the surface is directly exposed to the grill. Cooking is more gentle and can take a little longer. **Suitable for:** thicker meat; poultry.

Cooking meat and fish

Meat to be cooked in the oven should weigh at least **1kg**. Tender meat that you want cooked rare (roast beef, fillet, etc.), or which should be well cooked on the outside and retain all the juices on the inside, should be cooked on high temperatures for a short time (**200-250°C**). White meat, poultry and fish should be cooked on lower temperatures for a longer time (**150-175°C**).

The ingredients for any sauce should only be placed in the baking tray, at the beginning, if the cooking time is short. Otherwise, they should be added in, in the last half hour. Meat can be placed in an ovenproof dish or directly onto the shelf, below which a drip tray should be placed to collect the juice. Press the meat with a spoon to check if it is done. If it is firm, it is cooked.

At the end of the cooking, wait at least **15 minutes** before carving the meat, so as not to lose the juices. Before serving, plates can be warmed in the oven at minimum temperature.

Baking

Beaten mixtures should stick to the spoon because excess liquid will prolong the cooking time. Sweets require moderate temperatures (generally between **150-200°C**) and you should preheat the oven (**about 10 minutes**). The oven door must not be opened until at least $\frac{3}{4}$ of the way through the cooking time.

Recommended cooking tables

Cooking times vary according to the texture, consistency and volume of the food. We recommend monitoring your first attempts and checking the results, as similar results are obtained by cooking the same dishes in the same conditions. The following three tables (I, II and III) provide guidelines.

Table of fan and conventional cooking times (I)





TYPE OF COOKING	QUANTITY KG.	POSITION OF SHELF FROM BOTTOM		TEMPERATURE °C		TIME IN MINUTES
		CONVECTION 	TRADITIONAL 	CONVECTION 	TRADITIONAL 	
BAKING						
WITH BEATEN MIXTURE, IN A TIN	1	1-3	2	175	200	60
WITH BEATEN MIXTURE, ON THE DRIPPING PAN	1	1-3	2	175	200	50
SHORT PASTRY, PIE BASE	0.5	1-3	3	175	200	30
SHORT PASTRY WITH MOIST FILLING	1.5	1-3	2	175	200	70
SHORT PASTRY WITH DRY FILLING	1	1-3	2	175	200	45
MIXTURE WITH NATURAL LEAVENING	1	1-3	1	175	200	50
SMALL CAKES	0.5	1-3	3	160	175	30
MEAT						
VEAL	1	2	2	180	200	60
BEEF	1	2	2	180	200	70
ENGLISH STYLE ROAST BEEF	1	2	2	220	220	50
PORK	1	2	2	180	200	70
CHICKEN	1-1.5	2	2	200	200	70
STEWES						
BEEF STEW	1	1	2	175	200	120
VEAL STEW	1	1	2	175	200	110
FISH						
FILLET, STEAK, COD, HAKE, SOLE	1	1-3	2	180	180	30
MACKEREL, TURBOT, SALMON	1	1-3	2	180	180	45
OYSTERS	1	1-3	2	180	180	20
BAKES AND PASTRIES						
PASTA BAKE	2	1-3	2	185	200	60
VEGETABLE BAKE	2	1-3	2	185	200	50
SWEET AND SAVOURY SOUFFLÉS	0.75	1-3	2	180	200	50
PIZZA	0.5	1-3	2	200	220	30
<ul style="list-style-type: none"> • The times refer to cooking on one shelf only; for more than one shelf increase the time by 5-10'. • The cooking times do not include preheating which takes approximately 10'. • When cooking on more than one shelf, the guidelines given for the shelf position are the best positions. • For beef, veal, pork and turkey roasts, either with bone or rolled, increase the time by 20'. 						

Table of cooking times with grill and fan grilling (II)



 TRADITIONAL GRILLING				
TYPE OF COOKING	QUANTITY KG.	POSITION OF SHELF FROM BOTTOM	TEMPERATURE °C	TIME IN MINUTES
CHICKEN	1-1.5	3	MAX	30 PER SIDE
TOASTED SANDWICHES	0.5	4	MAX	5 PER SIDE
SAUSAGES	0.5	4	MAX	10 PER SIDE
PORK CHOPS	0.5	4	MAX	8 PER SIDE
FISH	0.5	4	MAX	8 PER SIDE
 GRILLING WITH THE FAN GRILL				
TYPE OF COOKING	QUANTITY KG.	POSITION OF SHELF FROM BOTTOM	TEMPERATURE °C	TIME IN MINUTES
ROAST PORK	1.5	2	170	180
ROAST BEEF	1.5	3	220	60
CHICKEN	1.2	2	190	90
• The dripping pan for collecting cooking juices should always be positioned in the 1 st guide from the bottom.				

Table of defrosting times (III)

 DEFROSTING			
TYPE OF COOKING	QUANTITY KG.	POSITION OF SHELF FROM BOTTOM	TIME IN MINUTES
READY-TO-EAT DISHES	1	2	45
MEAT	0.5	2	50
MEAT	0.75	2	70
MEAT	1	2	110
• Defrosting at room temperature has the advantage of not modifying the flavour and appearance of food.			

Maintenance and Cleaning



Before cleaning or carrying out maintenance, switch off the power supply to the cooker and close the gas taps.



Do not clean the surfaces of the cooker when they are still hot.



Do not use pressure or steam spray guns to clean the cooker.

Cleaning stainless steel

To clean and preserve stainless steel surfaces and remove the toughest stains, always use a specific products; **these products should not contain chlorine- based abrasives or acid substances, alternatively use a little warm vinegar.**

Pour the product onto a damp cloth and wipe the steel surface. Rinse carefully and dry with a soft cloth.

Do not under any circumstances use metallic sponges or sharp scrapers that may damage the surfaces. Only use non-scratch, non-abrasive sponges and, if necessary, wooden or plastic utensils.

Cleaning enamelled surfaces

Clean with a **non-abrasive** sponge dampened with soap and water. Grease stains can easily be removed with hot water or a product specifically made for cleaning enamel. Rinse carefully and dry with a soft cloth.

Do not use products containing abrasives, scouring pads, steel wool or acid, which may spoil the surfaces. Do not leave acid or alkaline substances on the enamel (lemon juice, vinegar, salt etc.).

Cleaning the control knobs and control panel

Clean the control knobs and panel with a damp cloth.

Cleaning the pan supports and burners

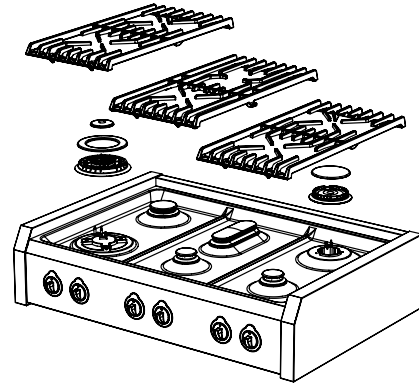

To clean the pan supports and hob burners, remove them from their housing by lifting them upwards (see diagram above) and soak them in warm soapy water with a mild, **non-abrasive** detergent for about ten minutes. Rinse and dry thoroughly.

Always check that the burner opening and jets are free of any soiling or impediments.

Be sure to refit the burners correctly, checking the flame is uniform.

We recommend carrying out this operation at least once a week and each time as necessary.

Cleaning the igniter plugs and thermocouples

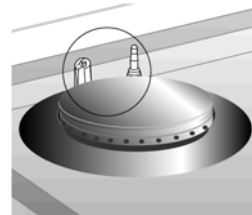

In order for the igniter plugs and thermocouples to operate correctly, they must be kept clean at all times. Check them frequently and, if necessary, clean them with a damp cloth. Any dry residue should be removed with a toothpick or needle, **taking care not to damage the insulating ceramic part.**

Cleaning the oven

In order to maintain the ovens efficiency and for hygienic reasons, it should be cleaned regularly, each time it is used if possible, **after leaving it to cool**: in this way it is possible to remove any residue more easily preventing it from burning the next time the oven is used.

Clean the stainless steel and enamelled parts as described in the corresponding sections "Cleaning stainless steel" and "Cleaning enamelled surfaces".

Take out all the removable parts and wash them separately. Rinse and dry thoroughly with a clean cloth.

Cleaning the Catalytic oven liners

Never use detergent products to clean this type of oven.

The walls of the oven can be cleaned using white vinegar and wiped with a cloth. Afterwards, heat the oven cavity (for at least one hour) to **150°C** to clean the liners. When the oven has cooled, wipe it again with a damp cloth.

Cleaning the door

We recommend you always keep the oven doors clean. Use kitchen roll or on tougher stains use a damp cloth and household detergent to clean the doors.



Spray products for cleaning the oven must not be used to clean the fan and the thermostat sensor inside the oven.

Replacing the light bulb



Before carrying out maintenance, switch off the power supply to the cooker.

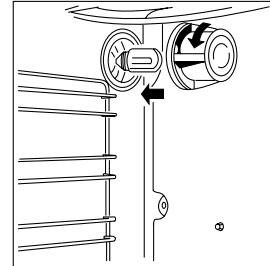

Proceed as follows:

- Open the oven door.
- Unscrew the glass safety cap anti-clockwise; unscrew the bulb and replace it with another one suitable for **high temperatures (300°C)** with the following specifications:

Voltage: 230V/50Hz
Power: 15 Watts
Attachment: E14

- Refit the glass cap and switch on the power. You can check that the oven light is working by turning the function control knob to the light setting .

Special Maintenance

Occasionally, it is necessary to maintain or replace some parts that are subject to wear and tear. Specific instructions are given below for each type of maintenance.

⚠ Before carrying out maintenance, switch off the power supply to the cooker and close the gas taps.

Removing the oven door

The oven door can be removed completely to make cleaning the oven easier. Though this is possible, the door is heavy, therefore this job should only be carried out by someone with the strength to lift and carry the door. It also requires a little expertise to refit it. If you are not you will be able to do this, we recommend that you clean the oven doors without removing them. In certain circumstances, you contact the nearest authorized service centre (see "Repairs - After Sales Service" on page 27).

To remove the door, proceed as follows:

- Open the oven door fully and release the safety catches on the hinges (one for each hinge) by lifting them (A) (see diagram below) back towards the oven door.
- Partially close the door until there is no more load tension on the springs (the door will form an angle of about 30°).
- Using both hands, grip the oven door on each side and close the door whilst simultaneously lifting it upwards.
- Pull the lower part of the door towards you to release the hinges (B, see diagram below) from their seats.

If you need to clean between the panes of glass, turn the door upside down (see diagram below), slide a soft bottle brush into the space between the glass panes and brush gently.

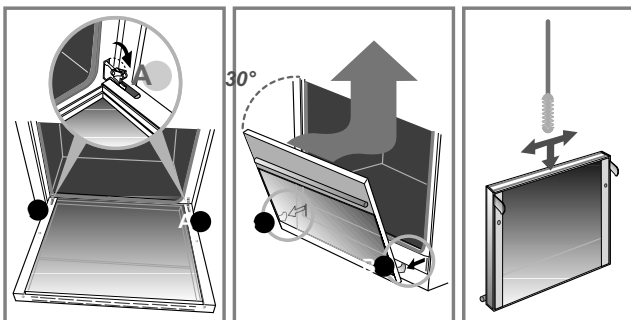

To refit the oven door, carry out the above instructions the reverse. When the hinges (B) are back in their seats, lower the oven door fully down and lower the safety catches on each hinge securely back in place (A)



⚠ CAUTION: After refitting the door, always be sure to refit the hinge safety catches.

Removing the shelf supports

The shelf supports can easily be removed for cleaning and to help clean the oven walls. The shelf supports are hooked to the oven walls in the three points indicated by the arrows in the figure (detail 1).

- Press the top of the shelf support downwards as shown in (picture 2) to release the shelf support from the upper pin.
- Lift the shelf support upwards and remove.

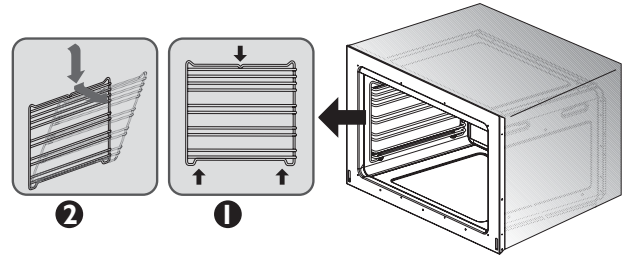

To refit the shelf support, carry out the instructions in the reverse order. Set the lower part of the shelf support in the respective pins and press the upper part towards the oven wall until it hooks into the pin.

Removal and cleaning the oven fan

The fan in main oven may occasionally need cleaning. To remove the cover panel and fan proceed as follows (see diagram below):

⚠ Make sure the power supply to the appliance is switched off.

- Remove all the oven accessories (shelf supports, shelves and grill pan).
- Loosen and remove the four screws (A) from the fan cover panel.
- Remove the fan cover panel (B)
- Use a coin to loosen the fixing nut (C) of the fan (this threading is in reverse, to loosen turn clockwise).
- Remove fan (D) and wash it using warm water and household detergent. **Never use abrasive or corrosive detergents, powdered products, or metal scrubbers.** Rinse the fan and dry thoroughly.

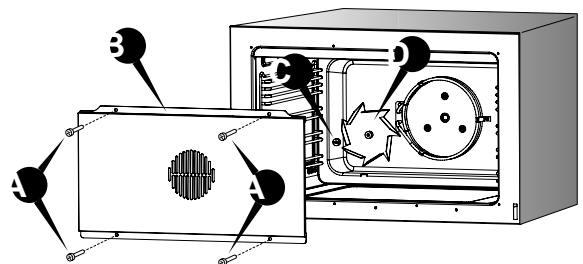

Refit the fan and cover panel by reversing the removal instructions.

Something Not Working

If the appliance is not working correctly, please carry out the following checks before contacting your local Service Force agent.



IMPORTANT : If you call out an engineer to a fault listed below, or to repair a fault caused by incorrect use or installation, a charge will be made even if the appliance is under guarantee.

Symptom	Solution
The ignition does not work:	<ul style="list-style-type: none">• The plug is not properly inserted in the power socket.• There is no current at the socket.
The burner does not ignite:	<ul style="list-style-type: none">• The gas is turned off.• There is no ignition spark.
The flame has no uniform distribution:	<ul style="list-style-type: none">• The burner plate is improperly assembled.• The burner is dirty.
The inner lamp is not working:	<ul style="list-style-type: none">• The plug is not properly inserted in the power socket.• There is no current at the socket.• The lamp is defective.
The oven is not warming up:	<ul style="list-style-type: none">• The plug is not properly inserted in the power socket.• There is no current at the socket.
The display light is blinking:	<ul style="list-style-type: none">• There has been a current interruption, the display needs to be programmed again (see page 14).

Repairs - After Sales Service

If your appliance is not working correctly; consult the fault finding guides within this instruction book (Something not working). If a fault occurs which you can not resolve through following the advice and information contained within this instruction manual, the next step is to contact our extended warranty administrators on

0870 010 7887

They will give you details for your local Service Force Centre.

Before calling out an engineer, please ensure you have read the details under the heading "Something Not Working".

When you contact your local Service Force Centre you will need to give the following details:

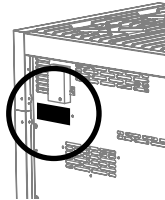

1. Your name, address and post code.
2. Your telephone number.
3. Clear and concise details of fault.
4. The purchase date and found on your receipt.
5. The model and serial number of the appliance.

So that you always have these numbers at hand, we recommend you to make a note of them here:

Mod. :

PNC :

S.N. :

i **Your cooker is covered by a 3 year parts and labour guarantee (see separate details given at point of sale). Please retain your purchase receipt safely for the service engineer to verify the purchase details.**

Spare parts

i **Always insist on genuine spare parts.**

An authorised service engineer should service this product, and only genuine spare parts should be used. Under no circumstances should you attempt to repair the machine your-self. Repairs carried out by inexperienced persons may cause injury or serious malfunctioning. Contact your local Service Force Centre. An authorised service engineer always insist on genuine spare parts.

John Lewis Partnership

171 Victoria Street
London SW1E 5NN
www.johnlewis.com